

MEDMASTER DOWNLIGHT

Luminaires for Medical Applications

MDL SERIES

PRODUCT FEATURES:

- » 6" sealed, recessed downlight with regressed or flush lens trim
- » Delivered lumens: 697 - 5,543 lm
- » 1% Dimming via 0-10V, DALI or EcoSystem control

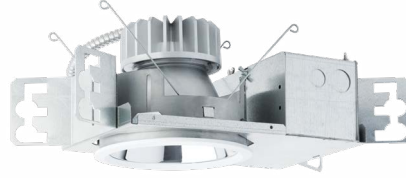

PROJECT INFORMATION

Job Name _____

Fixture Type _____

Catalog Number _____

Approved by _____

SPECIFICATIONS

HEAT SINK: Die-cast aluminum with external radial fins for natural convection.

ROUGH-IN FRAME: 18-gauge die-formed, corrosion-resistant steel. Vertically adjustable collar accommodates ceiling thicknesses up to 2", adjustable post-installation. Universal mounting brackets accept 3/4" and 1-1/2" lathers channel, 1/2" EMT conduit and hanger bars. Quick-access junction box accessible post-installation from above and below ceiling. Includes (4) 1/2" and (2) 3/4" knock-outs to allow straight conduit runs. Listed for (8) 12AWG, 90°C conductors and feed-thru branch wiring. Provided with FMC with electrical quick-connect to Trim Section.

TRIM/HOUSING SECTION: IP-rated housing section incorporates the heat sink, LED module, optics and lower trim. Configurable with an IP64-rated Regressed or Flush lens trim that is secured to the Rough-In frame with hidden torsion springs, and an IP65 Flush lens trim secured with four (4) Phillips-head, captive fasteners. Anti-microbial finish standard on all exposed painted surfaces. See trim ordering information for available options.

OPTICAL: High-Efficiency mixing chamber design with regressed diffused tempered-glass lens producing uniform light output. Available with various reflector distribution patterns and finishes. Flush lens trim options include a clear lens. See distribution and reflector finish ordering information for available options.

ELECTRICAL: LED array available in multiple CCT and CRI combinations with a maximum 3-step MacAdam variation allowance. See Trim Ordering Information for available options. 120-277VAC or 347VAC, 50/60Hz electrical input with serviceable constant current driver (<20% THD, >0.90 PF). Minimum 85% driver efficiency. Standard 0-10V dimming with 1-100% range and dim-to-dark capabilities (non dim-to-dark with 347V); 165µA maximum source current. Optional eldoLED ECOdrive DALI driver with 1-100% range and Lutron Hi-Lume 1% EcoSystem LED driver with Soft-on, Fade-to-Black dimming technology.

PHOTOMETRICS: Photometry tested to the IESNA LM-79-08 standard by an ILAC/ISO17025 accredited laboratory. For photometric information, go to www.kenall.com.

WARRANTY: Limited five (5) year LED warranty.

LISTINGS: Luminaire is certified to UL standards by Intertek Testing Laboratory for non-IC and Wet Location installations. IP64 and IP65 rating per IEC60598. NSF2 Splash/Non-Food Zone. Optional CCEA compliance.



ORDERING INFORMATION (EX: MDL6-FF-2FW-22L-40K8-W-CSS-T-RIG6-DV-DIM1)

TRIM

Model	Trim Style	Trim Finish	Lamp Power	Lamp Color	Distribution	Reflector Finish	Flush Lens Type
-------	------------	-------------	------------	------------	--------------	------------------	-----------------

MDL6

Trim Style

- R** Regressed Lens (IP64)
- NF** Flush Lens (Without Fasteners - IP64)
- FF** Flush Lens (With Fasteners - IP65)

Trim Finish

- DCFW** Die-Cast Aluminum in Flat White (R and NF Trim Style)
- 2FW** Cold-Rolled Steel in Flat White
- 5BR** Type 304 Stainless Steel with 4B Brushed Finish

Lamp Power

- 12L** 12 Watt LED
- 22L** 22 Watt LED
- 33L** 33 Watt LED
- 55L+▲** 55 Watt LED

Lamp Color

- 30K8** 3000K / 80 CRI min.
- 30K9** 3000K / 90 CRI min.
- 35K8** 3500K / 80 CRI min.
- 35K9** 3500K / 90 CRI min.
- 40K8** 4000K / 80 CRI min.
- 40K9** 4000K / 90 CRI min.
- 50K8** 5000K / 80 CRI min.

Distribution

- M** Medium
- W** Wide
- WW*** Wall Wash

Reflector Finish

- FW** Flat White
- CS** Clear Specular
- CSS** Clear Semi-Specular

Flush Lens Type (n/a Regressed Trim Style)

- T** 1/8" Clear High-Impact Acrylic

ROUGH-IN

Rough-In	Input Voltage	Driver Type	Options
----------	---------------	-------------	---------

RIG6

Rough-In

- RIG6** 6" Rough-In

Input Voltage

- DV** 120-277V, 50/60Hz
- 120** 120VAC, 60Hz
- 277** 277VAC, 60Hz
- 347†** 347VAC, 60Hz

Driver Type

- DIM1** 0-10V Dimming to 1%
- DALI** DALI Dimming to 1%
- ECO1** Lutron Hi-Lume 1% EcoSystem®

Options

- LEL** Emergency Battery Backup with Remote Test Switch
- FS** Fuse & Holder
- CCEA** CCEA Approved (specified voltage required; n/a 347V)

* Available with CSS reflector finish only

† N/A with DALI or ECO1 Driver Type. N/A with LEL option

▲ Must be installed with a minimum 24" on-center spacing, 12" from wall, and have 3" clearance above the Trim/Housing



www.kenall.com | P: 800-4-Kenall | F: 262-891-9701 | 10200 55th Street Kenosha, Wisconsin 53144, USA

A brand of **legrand**

This product complies with the Buy American Act: manufactured in the United States with more than 50% of the component cost of US origin. It may be covered by patents found at www.kenall.com/patents. Content of specification sheets is subject to change; please consult www.kenall.com for current product details. ©2019 Kenall Mfg. Co.

MEDMASTER DOWNLIGHT

Luminaires for Medical Applications

MDL SERIES

PERFORMANCE - REGRESSED LENS

Optic		Lamp Power	Initial Delivered Lumens, By Lamp Color							Efficacy (lm/W)	Input Power (W)	Estd. L70 LED Life (hrs)
Distribution	Reflector Finish		30K8	30K9	35K8	35K9	40K8	40K9	50K8			
M	CS	12L	1,121	937	1,121	949	1,166	949	1,191	62 - 79	15	80,000
		22L	1,836	1,535	1,836	1,553	1,909	1,553	1,950	64 - 81	24	85,000
		33L	2,660	2,224	2,660	2,251	2,766	2,251	2,826	64 - 81	35	70,000
		55L	4,745	3,967	4,745	4,015	4,934	4,015	5,041	64 - 81	62	75,000
	CSS	12L	1,052	880	1,052	891	1,094	891	1,118	59 - 75	15	80,000
		22L	1,723	1,441	1,723	1,458	1,792	1,458	1,831	60 - 76	24	85,000
		33L	2,497	2,087	2,497	2,113	2,596	2,113	2,653	60 - 76	35	70,000
		55L	4,454	3,724	4,454	3,769	4,632	3,769	4,732	60 - 76	62	75,000
	FW	12L	1,214	1,015	1,214	1,028	1,263	1,028	1,290	68 - 86	15	80,000
		22L	1,989	1,663	1,989	1,683	2,068	1,683	2,113	69 - 88	24	85,000
		33L	2,881	2,409	2,881	2,438	2,996	2,438	3,061	69 - 87	35	70,000
		55L	5,140	4,298	5,140	4,350	5,345	4,350	5,461	69 - 88	62	75,000
W	CS	12L	1,233	1,031	1,233	1,043	1,282	1,043	1,310	70 - 90	15	80,000
		22L	2,018	1,688	2,018	1,708	2,099	1,708	2,144	70 - 89	24	85,000
		33L	2,924	2,445	2,924	2,475	3,041	2,475	3,107	70 - 89	35	70,000
		55L	5,217	4,362	5,217	4,415	5,425	4,415	5,543	70 - 89	62	75,000
	CSS	12L	1,085	907	1,085	918	1,128	918	1,152	62 - 79	15	80,000
		22L	1,776	1,485	1,776	1,503	1,847	1,503	1,887	62 - 79	24	85,000
		33L	2,573	2,152	2,573	2,178	2,676	2,178	2,734	61 - 78	35	70,000
		55L	4,590	3,838	4,590	3,885	4,774	3,885	4,877	62 - 79	62	75,000
	FW	12L	1,176	984	1,176	995	1,223	995	1,250	67 - 85	15	80,000
		22L	1,926	1,610	1,926	1,630	2,003	1,630	2,046	67 - 85	24	85,000
		33L	2,790	2,333	2,790	2,362	2,902	2,362	2,965	67 - 85	35	70,000
		55L	4,978	4,163	4,978	4,213	5,177	4,213	5,289	67 - 85	62	75,000
WW	CSS	12L	918	768	918	777	955	777	976	51 - 65	15	80,000
		22L	1,504	1,257	1,504	1,273	1,564	1,273	1,598	52 - 67	24	85,000
		33L	2,179	846	2,179	1,844	2,266	1,844	2,315	24 - 66	35	70,000
		55L	3,887	3,250	3,887	3,290	4,043	3,290	4,130	52 - 67	62	75,000

Subject to change without notice. Visit www.kenall.com for ies files and additional information.



www.kenall.com | P: 800-4-Kenall | F: 262-891-9701 | 10200 55th Street Kenosha, Wisconsin 53144, USA

A brand of Legrand

This product complies with the Buy American Act: manufactured in the United States with more than 50% of the component cost of US origin. It may be covered by patents found at www.kenall.com/patents. Content of specification sheets is subject to change; please consult www.kenall.com for current product details. ©2019 Kenall Mfg. Co.

MEDMASTER DOWNLIGHT

Luminaires for Medical Applications

MDL SERIES

For additional photometry, go to www.kenall.com

PERFORMANCE - REGRESSED LENS

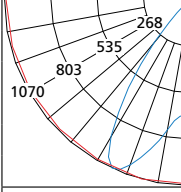
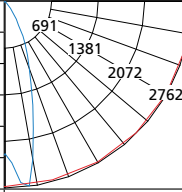
Wide Distribution Candela Curve	MDL6-R-12L-40K8-W-CS		Distance to illuminated plane (ft)	MDL6-R-12L-40K8-M-CS		Medium Distribution Candela Curve
	Initial center beam foot-candles	Beam diameter (ft)		Initial center beam foot-candles	Beam diameter (ft)	
	29.7	7.5	5'	63.6	3.5	
	23.8	7.8	6'	44.2	4.6	
	17.4	8.6	7'	32.5	4.8	
	13.3	9.8	8'	24.9	5.5	
	10.6	11.2	9'	19.6	6.2	
	8.6	13.0	10'	15.9	6.9	
Spacing Criteria: 1.42	foot-candle multipliers for 30K8(.96), 30K9(.80), 35K8(.96), 35K9(.81), 40K9(.81), 50K8(1.0)				Spacing Criteria: 0.64	
Beam Angle: 73°	Beam diameter is where foot-candles drop to 50% of maximum				Beam Angle: 34°	

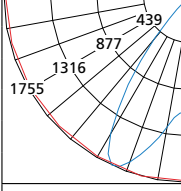
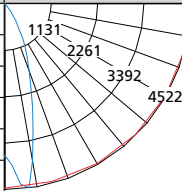
Wide Distribution Candela Curve	MDL6-R-22L-40K8-W-CS		Distance to illuminated plane (ft)	MDL6-R-22L-40K8-M-CS		Medium Distribution Candela Curve
	Initial center beam foot-candles	Beam diameter (ft)		Initial center beam foot-candles	Beam diameter (ft)	
	48.6	7.8	5'	104.2	3.5	
	38.9	8.0	6'	72.4	4.7	
	28.5	8.6	7'	53.2	4.8	
	21.8	10.2	8'	40.2	5.5	
	17.3	11.5	9'	32.2	6.2	
	14.0	13.0	10'	26.1	6.9	
Spacing Criteria: 1.42	foot-candle multipliers for 30K8(.96), 30K9(.80), 35K8(.96), 35K9(.81), 40K9(.81), 50K8(1.0)				Spacing Criteria: 0.64	
Beam Angle: 73°	Beam diameter is where foot-candles drop to 50% of maximum				Beam Angle: 34°	

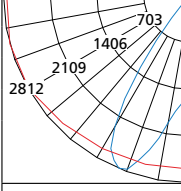
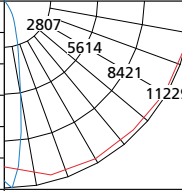
Wide Distribution Candela Curve	MDL6-R-33L-40K8-W-CS		Distance to illuminated plane (ft)	MDL6-R-33L-40K8-M-CS		Medium Distribution Candela Curve
	Initial center beam foot-candles	Beam diameter (ft)		Initial center beam foot-candles	Beam diameter (ft)	
	70.5	7.8	5'	151.0	3.5	
	56.4	8.0	6'	104.9	4.7	
	41.3	8.6	7'	77.0	4.8	
	31.7	10.2	8'	59.0	5.5	
	25.1	11.5	9'	46.6	6.2	
	20.3	13.0	10'	37.8	6.9	
Spacing Criteria: 1.36	foot-candle multipliers for 30K8(.96), 30K9(.80), 35K8(.96), 35K9(.81), 40K9(.81), 50K8(1.0)				Spacing Criteria: 0.36	
Beam Angle: 69°	Beam diameter is where foot-candles drop to 50% of maximum				Beam Angle: 21°	

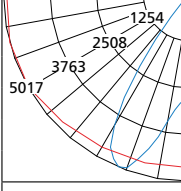
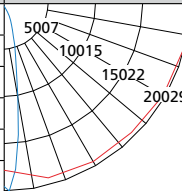
Wide Distribution Candela Curve	MDL6-R-55L-40K8-W-CS		Distance to illuminated plane (ft)	MDL6-R-55L-40K8-M-CS		Medium Distribution Candela Curve
	Initial center beam foot-candles	Beam diameter (ft)		Initial center beam foot-candles	Beam diameter (ft)	
	125.7	7.8	5'	269.3	3.5	
	100.6	8.0	6'	187.0	4.7	
	73.7	8.6	7'	137.4	4.8	
	56.5	10.2	8'	105.2	5.5	
	44.8	11.5	9'	83.1	6.2	
	36.3	13.0	10'	67.3	6.9	
Spacing Criteria: 1.36	foot-candle multipliers for 30K8(.95), 30K9(.80), 35K8(.96), 35K9(.81), 40K9(.81), 50K8(1.0)				Spacing Criteria: 0.36	
Beam Angle: 69°	Beam diameter is where foot-candles drop to 50% of maximum				Beam Angle: 21°	



www.kenall.com | P: 800-4-Kenall | F: 262-891-9701 | 10200 55th Street Kenosha, Wisconsin 53144, USA

A brand of **legrand**

This product complies with the Buy American Act: manufactured in the United States with more than 50% of the component cost of US origin. It may be covered by patents found at www.kenall.com/patents. Content of specification sheets is subject to change; please consult www.kenall.com for current product details. ©2019 Kenall Mfg. Co.

MEDMASTER DOWNLIGHT
Luminaires for Medical Applications
MDL SERIES

For additional photometry, go to www.kenall.com

PERFORMANCE - FLUSH LENS

Optic		Lamp Power	Initial Delivered Lumens, By Lamp Color							Efficacy (lm/W)	Input Power (W)	Estd. L70 LED Life (hrs)
Distribution	Reflector Finish		30K8	30K9	35K8	35K9	40K8	40K9	50K8			
M	CS	12L	1,024	856	1,024	867	1,065	867	1,088	57 - 73	15	80,000
		22L	1,677	1,402	1,677	1,419	1,744	1,419	1,782	58 - 74	24	85,000
		33L	2,430	2,032	2,430	2,056	2,527	2,056	2,581	58 - 74	35	70,000
		55L	4,334	3,624	4,334	3,668	4,508	3,668	4,605	58 - 74	62	75,000
	CSS	12L	961	804	961	814	1,000	814	1,021	54 - 68	15	80,000
		22L	1,574	1,316	1,574	1,332	1,637	1,332	1,672	55 - 70	24	85,000
		33L	2,281	1,907	2,281	1,930	2,372	1,930	2,423	54 - 69	35	70,000
		55L	4,069	3,402	4,069	3,443	4,231	3,443	4,323	55 - 70	62	75,000
	FW	12L	950	794	950	804	988	804	1,009	53 - 67	15	80,000
		22L	1,555	1,300	1,555	1,316	1,617	1,316	1,652	54 - 69	24	85,000
		33L	2,253	1,884	2,253	1,906	2,343	1,906	2,394	54 - 68	35	70,000
		55L	4,019	3,360	4,019	3,401	4,180	3,401	4,270	54 - 69	62	75,000
W	CS	12L	1,153	964	1,153	976	1,199	976	1,225	66 - 84	15	80,000
		22L	1,888	1,578	1,888	1,597	1,963	1,597	2,006	66 - 84	24	85,000
		33L	2,735	2,287	2,735	2,314	2,844	2,314	2,906	65 - 83	35	70,000
		55L	4,879	4,079	4,879	4,129	5,074	4,129	5,184	66 - 84	62	75,000
	CSS	12L	978	818	978	828	1,017	828	1,039	56 - 71	15	80,000
		22L	1,602	1,339	1,602	1,356	1,666	1,356	1,702	56 - 71	24	85,000
		33L	2,321	1,941	2,321	1,964	2,414	1,964	2,466	55 - 70	35	70,000
		55L	4,141	3,462	4,141	3,504	4,306	3,504	4,399	56 - 71	62	75,000
	FW	12L	1,084	906	1,084	917	1,127	917	1,152	62 - 79	15	80,000
		22L	1,775	1,484	1,775	1,502	1,846	1,502	1,886	62 - 79	24	85,000
		33L	2,572	2,150	2,572	2,176	2,675	2,176	2,732	61 - 78	35	70,000
		55L	4,588	3,836	4,588	3,883	4,771	3,883	4,875	62 - 79	62	75,000
WW	CSS	12L	833	697	833	705	867	705	885	46 - 59	15	80,000
		22L	1,364	1,141	1,364	1,155	1,419	1,155	1,450	48 - 60	24	85,000
		33L	1,977	1,653	1,977	1,673	2,056	1,673	2,100	47 - 60	35	70,000
		55L	3,527	2,949	3,527	2,985	3,668	2,985	3,747	48 - 60	62	75,000

Subject to change without notice. Visit www.kenall.com for ies files and additional information.



www.kenall.com | P: 800-4-Kenall | F: 262-891-9701 | 10200 55th Street Kenosha, Wisconsin 53144, USA

A brand of **Legrand**

This product complies with the Buy American Act: manufactured in the United States with more than 50% of the component cost of US origin. It may be covered by patents found at www.kenall.com/patents. Content of specification sheets is subject to change; please consult www.kenall.com for current product details. ©2019 Kenall Mfg. Co.

MEDMASTER DOWNLIGHT

Luminaires for Medical Applications

MDL SERIES

PERFORMANCE - FLUSH LENS

Wide Distribution Candela Curve	MDL6-FF-12L-40K8-W-CS-T		Distance to illuminated plane (ft)	MDL6-FF-12L-40K8-M-CS-T		Medium Distribution Candela Curve
	Initial center beam foot-candles	Beam diameter (ft)		Initial center beam foot-candles	Beam diameter (ft)	
	27.8	7.5	5'	84.4	3.2	
	22.0	7.8	6'	58.6	3.5	
	16.1	9.0	7'	43.1	4.0	
	12.3	11.0	8'	33.0	4.6	
	9.8	11.7	9'	26.0	5.2	
	7.9	12.6	10'	21.1	5.8	
Spacing Criteria: 1.4	foot-candle multipliers for 30K8(.96), 30K9(.80), 35K8(.96), 35K9(.81), 40K9(.81), 50K8(1.0)				Spacing Criteria: 0.62	
Beam Angle: 59°	Beam diameter is where foot-candles drop to 50% of maximum				Beam Angle: 34°	

Wide Distribution Candela Curve	MDL6-FF-22L-40K8-W-CS-T		Distance to illuminated plane (ft)	MDL6-FF-22L-40K8-M-CS-T		Medium Distribution Candela Curve
	Initial center beam foot-candles	Beam diameter (ft)		Initial center beam foot-candles	Beam diameter (ft)	
	45.5	7.5	5'	138.2	3.2	
	36.0	7.8	6'	96.0	3.5	
	26.3	9.0	7'	70.5	4.0	
	20.2	11.0	8'	54.0	4.6	
	16.1	11.7	9'	42.7	5.2	
	13.0	12.6	10'	34.5	5.8	
Spacing Criteria: 1.4	foot-candle multipliers for 30K8(.96), 30K9(.80), 35K8(.96), 35K9(.81), 40K9(.81), 50K8(1.0)				Spacing Criteria: 0.62	
Beam Angle: 59°	Beam diameter is where foot-candles drop to 50% of maximum				Beam Angle: 34°	

Wide Distribution Candela Curve	MDL6-FF-33L-40K8-W-CS-T		Distance to illuminated plane (ft)	MDL6-FF-33L-40K8-M-CS-T		Medium Distribution Candela Curve
	Initial center beam foot-candles	Beam diameter (ft)		Initial center beam foot-candles	Beam diameter (ft)	
	65.9	7.5	5'	200.2	3.2	
	52.1	7.8	6'	139.0	3.5	
	38.2	9.0	7'	102.2	4.0	
	29.3	11.0	8'	78.2	4.6	
	23.3	11.7	9'	61.8	5.2	
	18.8	12.6	10'	50.1	5.8	
Spacing Criteria: 1.36	foot-candle multipliers for 30K8(.96), 30K9(.80), 35K8(.96), 35K9(.81), 40K9(.81), 50K8(1.0)				Spacing Criteria: 0.36	
Beam Angle: 54°	Beam diameter is where foot-candles drop to 50% of maximum				Beam Angle: 21°	

Wide Distribution Candela Curve	MDL6-FF-55L-40K8-W-CS-T		Distance to illuminated plane (ft)	MDL6-FF-55L-40K8-M-CS-T		Medium Distribution Candela Curve
	Initial center beam foot-candles	Beam diameter (ft)		Initial center beam foot-candles	Beam diameter (ft)	
	117.6	7.5	5'	357.2	3.2	
	93.0	7.8	6'	248.0	3.5	
	68.1	9.0	7'	182.2	4.0	
	52.2	11.0	8'	139.5	4.6	
	41.5	11.7	9'	110.2	5.2	
	33.6	12.6	10'	89.3	5.8	
Spacing Criteria: 1.36	foot-candle multipliers for 30K8(.96), 30K9(.80), 35K8(.96), 35K9(.81), 40K9(.81), 50K8(1.0)				Spacing Criteria: 0.36	
Beam Angle: 54°	Beam diameter is where foot-candles drop to 50% of maximum				Beam Angle: 21°	



www.kenall.com | P: 800-4-Kenall | F: 262-891-9701 | 10200 55th Street Kenosha, Wisconsin 53144, USA

A brand of **legrand**

This product complies with the Buy American Act: manufactured in the United States with more than 50% of the component cost of US origin. It may be covered by patents found at www.kenall.com/patents. Content of specification sheets is subject to change; please consult www.kenall.com for current product details. ©2019 Kenall Mfg. Co.

MEDMASTER DOWNLIGHT

Luminaires for Medical Applications

MDL SERIES

DIMENSIONAL DATA

CROSS SECTION

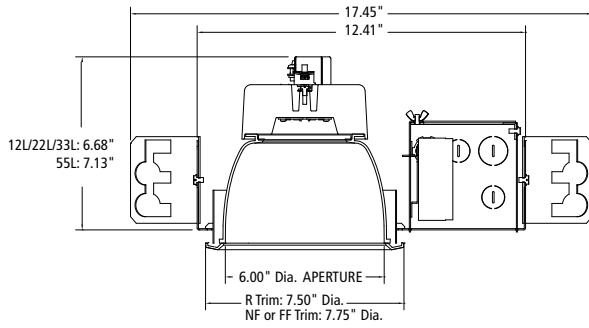

BOTTOM VIEW

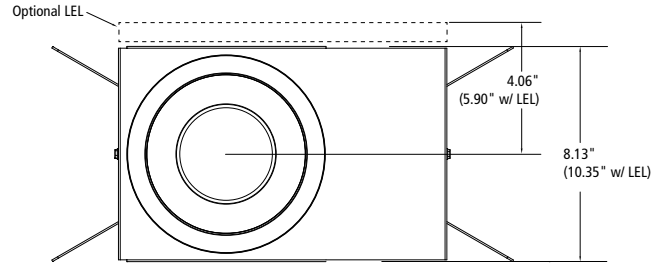

RECOMMENDED CEILING CUT-OUT
R and NF Trims: 7.13" Dia.
FF Trims: 7.38" Dia.



www.kenall.com | P: 800-4-Kenall | F: 262-891-9701 | 10200 55th Street Kenosha, Wisconsin 53144, USA

A brand of **legrand**

This product complies with the Buy American Act: manufactured in the United States with more than 50% of the component cost of US origin. It may be covered by patents found at www.kenall.com/patents. Content of specification sheets is subject to change; please consult www.kenall.com for current product details. ©2019 Kenall Mfg. Co.