

# MILLENIUM AURACYL™ SCONCE

## MLAS838 SERIES



### PRODUCT FEATURES:

- » Surface wall mount – 8"W×38"H
- » Marine grade aluminum housing with die-cast end caps
- » Peace of Mind Guarantee®
- » UL certified IP64 per IEC 60598

### SPECIFICATIONS

**HOUSING:** Marine grade extruded aluminum. Marine grade die-cast aluminum end caps. TGIC polyester powder coat – 5-stage pre-treatment; Salt spray test: 1,000 hours.

**REFLECTOR:** Die-formed marine grade aluminum. Full reflector/wire cover – 92% reflectivity.

**OUTER LENS:** Thermoformed, UV-stabilized impact resistant polycarbonate, and frost or clear acrylic. See Ordering Information for options. Nominal thickness .125".

**INNER LENS:** UV-stabilized, high impact resistant, extruded 100% DR acrylic frost lens. Nominal thickness .100". Lens secured in place by lens frame.

**HARDWARE:** Six stainless steel Torx® T-20 with center pin fasteners. Internal brackets and fasteners are non-corrosive. Surface Conduit Adapter (SCA) accessory – aluminum trim frame assembly with integral J-box; finished to match lens frame. Water-tight conduit fittings supplied by others.

**ELECTRICAL:** Available 3500K, 4000K and 5000K color temperatures, 82 CRI. 120-277VAC, 50/60Hz electrical input with serviceable high power factor electronic, constant-current driver (<20% THD, >0.95 PF). Standard 0-10V dimming with 1-100% range, maximum driver source of 200 µA. Consult factory for fluorescent option.

**PHOTOMETRICS:** Photometry tested to the IESNA LM-79-08 standard by an ILAC/ISO17025 accredited laboratory. For photometric information, go to [www.kenall.com](http://www.kenall.com).

**WARRANTY:** Limited five (5) year LED warranty. [Peace of Mind Guarantee against breakage.](#)

**LISTINGS:** UL and CUL listed for Wet Location – vertical wall mount only. UL certified IP64 per IEC 60598. ADA Compliant (SCA Option is non-ADA). Luminaire tested to an IK10 impact protection rating per IEC 60068-2-75:1997-08.



### PROJECT INFORMATION

Job Name \_\_\_\_\_

Fixture Type \_\_\_\_\_

Catalog Number \_\_\_\_\_

Approved by \_\_\_\_\_

### ORDERING INFORMATION (Ex: MLAS838-PRA-PP-MB-33L35K-DCC-DV-FS)

Model	Frame Type	Outer Lens	Finish	Lamp-Driver-Voltage	Options
<b>MLAS838</b>	<b>Frame Type</b> <b>PAN</b> Pane <b>PLR</b> Pillar <b>CPL</b> Capital <b>SLT</b> Slot <b>PRA</b> Prairie <b>RNK</b> Rank <b>LAT</b> Lattice <b>SQR</b> Squares <b>BRK</b> Bricks <b>ORB</b> Orbs	<b>Outer Lens</b> <b>AS†</b> Frosted Acrylic <b>CAP†</b> Clear Acrylic w/Inner Perforation painted to match housing <b>PP</b> Pearlescent Polycarbonate tn/a with Peace of Mind Guarantee®	<b>Finish</b> <b>MB</b> Matte Black <b>MW</b> Matte White <b>WS</b> Warm Satin Painted Anodized <b>CS</b> Cool Satin Painted Anodized <b>BR</b> Bronze <b>DB</b> Dark Bronze <b>LG</b> Light Gray <b>FG</b> Forest Green <b>CC</b> Custom Color (Consult factory)	<b>Lamp-Driver-Voltage</b> <b>33L35K-DCC-DV</b> 33 Watt 3500K LED <b>33L40K-DCC-DV</b> 33 Watt 4000K LED <b>33L50K-DCC-DV</b> 33 Watt 5000K LED	<b>Options</b> <b>FS</b> Single Fuse & Holder <b>SCA</b> Surface Conduit Adapter (non-ADA compliant)

### FRAME TYPE

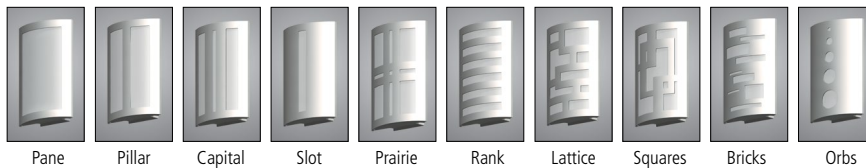

### OUTER LENS OPTIONS



[www.kenall.com](http://www.kenall.com) | P: 800-4-Kenall | F: 262-891-9700 | 10200 55th Street Kenosha, Wisconsin 53144, USA  
 This product is able to comply with the latest domestic preference legislation, such as the Buy American Act (BAA), Trade Agreement Act (TAA), Build America, Buy America Act (BABA), and others. It may be covered by patents found at [www.kenall.com/patents](http://www.kenall.com/patents). Content of specification sheets is subject to change; please consult [www.kenall.com](http://www.kenall.com) for current product details. ©2024 Kenall Mfg. Co.

A brand of **Legrand**

# MILLENIUM AURACYL™ SCNCE

## MLAS838 SERIES – Technical Data

### PERFORMANCE

Lamp Type	Initial Delivered Lumens		Input Power (W)	Drive Current (mA)	Estd. L70 LED Life (Hrs)
	@ 25°C (lm)	Efficacy (lm/W)			
33L35K	1842	51	36	94	80,000
33L40K	1964	55	36	94	80,000
33L50K	2043	57	36	94	80,000

Displayed information above is for PP Lens type only. Info subject to change. Visit [www.kenall.com](http://www.kenall.com) for IES files and additional information.

Model: MLAS838-PAN-PP-MW-33L40K-DV

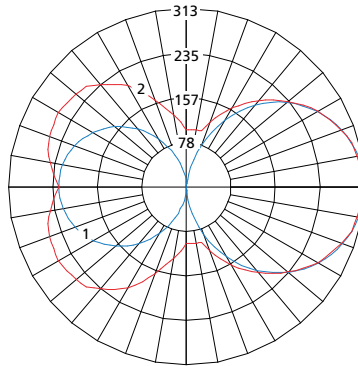

Maximum Candela = 313 Located At Horizontal Angle = 0, Vertical Angle = -90  
 — 1 - Vertical Plane Through Horizontal Angles (0-180) (Through Max. Cd.)  
 — 2 - Horizontal Cone Through Vertical Angle (90) (Through Max. Cd.)

### DIMENSIONAL DATA

#### CROSS SECTION

#### SURFACE CONDUIT ADAPTER (SCA)

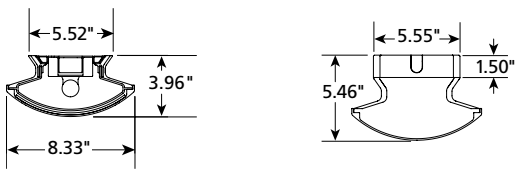

#### INSTALLATION DETAILS

#### (SCA)

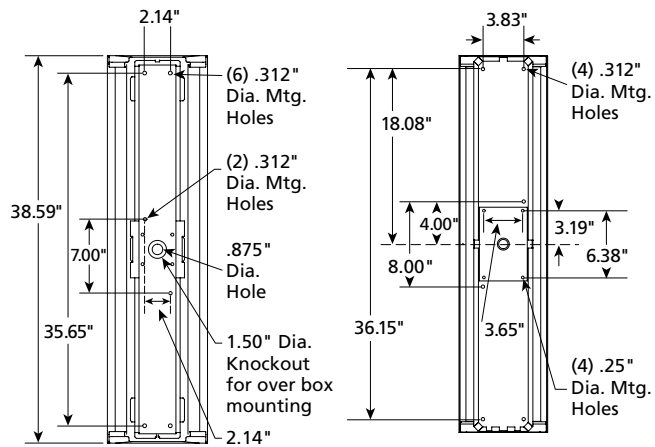

# SCONCE DECORATIVE FRAME STYLES

Pane



Pillar



Capital



Slot



Prairie



Rank



Lattice



Squares



Bricks



Orbs



## MILLENNIUM AURACYL SCONCE FINISH OPTIONS

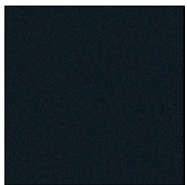

MB Matte Black

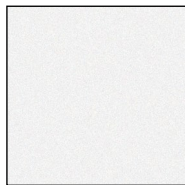

MW Matte White



WS Warm Satin



CS Cool Satin



BR Bronze



DB Dark Bronze

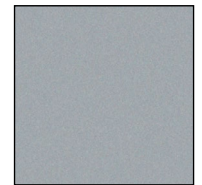

LG Light Gray

Please consult Kenall for custom color availability



www.kenall.com | P: 800-4-Kenall | F: 262-891-9701 | 10200 55th Street Kenosha, Wisconsin 53144, USA

This product complies with the Buy American Act: manufactured in the United States with more than 50% of the component cost of US origin. It may be covered by patents found at [www.kenall.com/patents](http://www.kenall.com/patents). Content of specification sheets is subject to change; please consult [www.kenall.com](http://www.kenall.com) for current product details. ©2019 Kenall Mfg. Co.

A brand of  Legrand